

Section 5:

Geometry

Words to Know: Line, Angle, Parallel, Perpendicular, Intersecting, Coordinate Plane, Quadrant, Area, Surface Area, Volume, Congruence, Similarity, Pythagorean

Name : _____

Score : _____

Teacher : _____

Date : _____

Identify Parallel, Perpendicular, and Intersecting Lines

Identify the given pair of lines as either parallel, perpendicular, or intersecting.

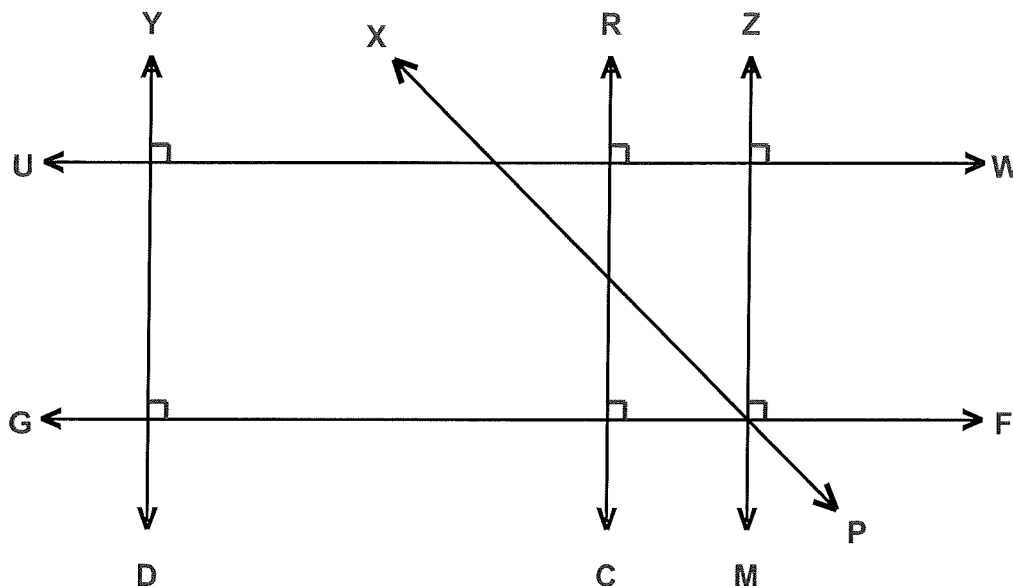

1) Line GF and Line YD are _____ lines.	6) Line ZM and Line RC are _____ lines.
2) Line XP and Line RC are _____ lines.	7) Line UW and Line XP are _____ lines.
3) Line UW and Line ZM are _____ lines.	8) Line UW and Line RC are _____ lines.
4) Line ZM and Line XP are _____ lines.	9) Line GF and Line XP are _____ lines.
5) Line UW and Line GF are _____ lines.	10) Line YD and Line ZM are _____ lines.



Perpendicular Lines (A)

Construct a line perpendicular to the segment through the unlabeled point.

1.

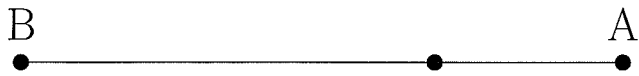

2.

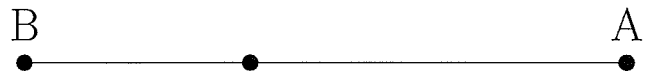

3.



4.

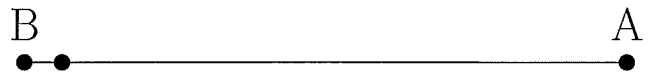

Vertical Angles (A)

Find the vertical angle measurements for the measured angles.

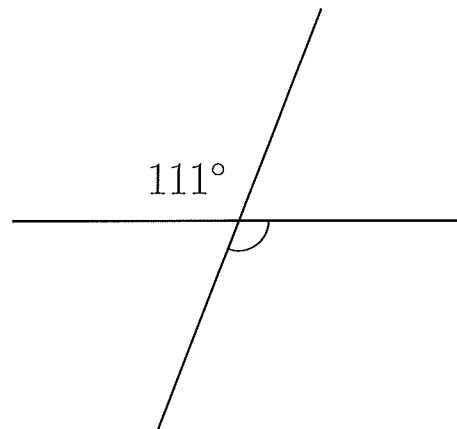
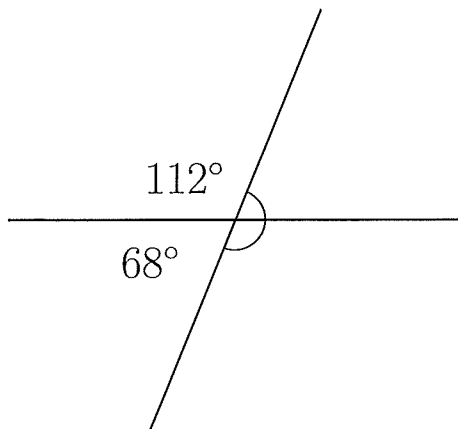
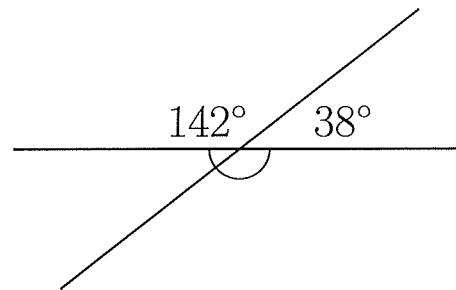
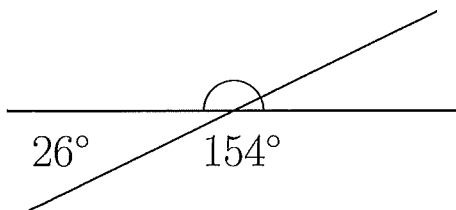
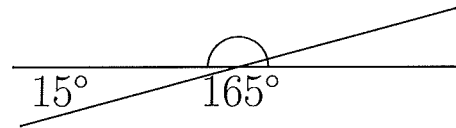
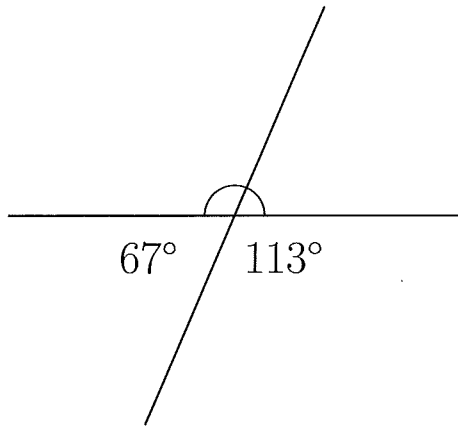

Complementary Angles (A)

Find the complementary angle measurement for each measured angle.

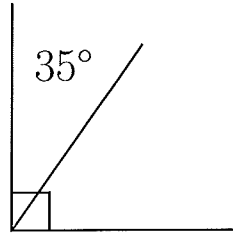
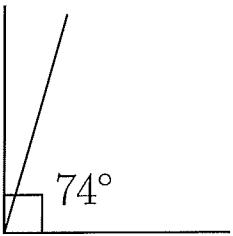
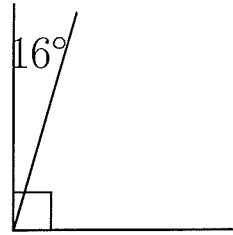
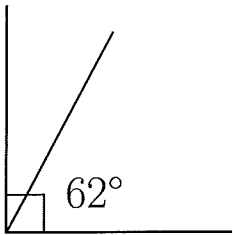
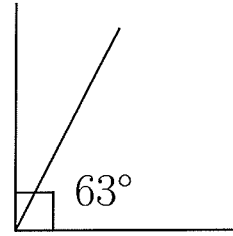
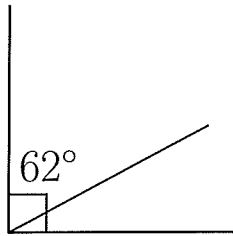

Supplementary Angles (A)

Find the supplementary angle measurement for each measured angle.

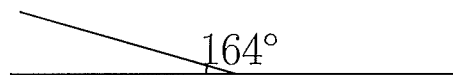
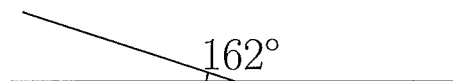
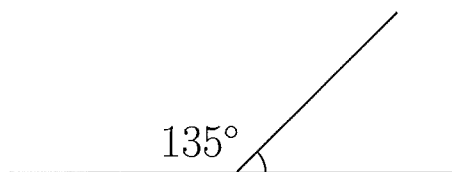
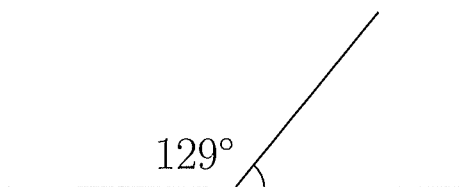

Classifying Triangles by Angle and Side Properties (A)

Name: _____

Date: _____

Classify each triangle using its angle and side properties.

1.

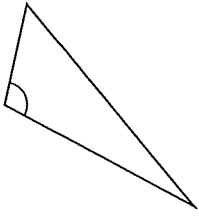

2.

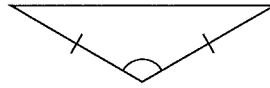

3.

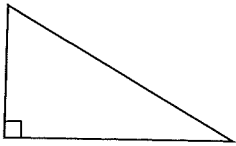

4.

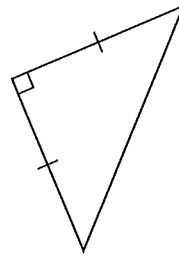

5.

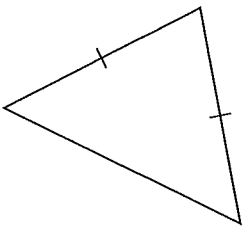

6.

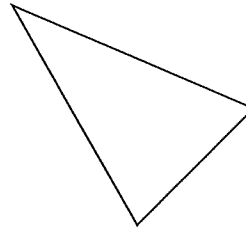

7.

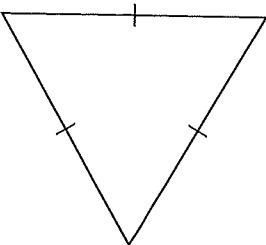

8.

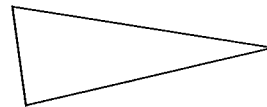

9.

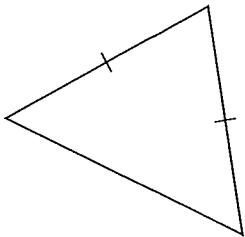

10.

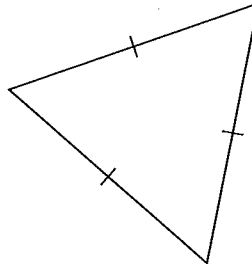

Classifying Quadrilaterals (A)

Identify each quadrilateral.

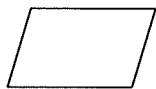

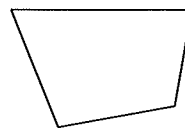

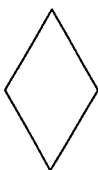





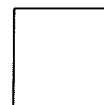

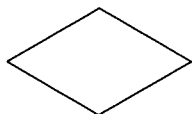



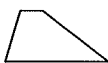



Plotting Coordinate Points (A)

Plot the coordinate points below.

$(-4, 10)$ $(7, -9)$ $(0, 9)$ $(-8, 6)$ $(-4, -6)$ $(6, 5)$ $(-3, -1)$ $(5, 5)$
 $(-5, 6)$ $(-3, -6)$ $(-1, -6)$ $(5, 9)$ $(8, 6)$ $(1, 5)$ $(-4, 9)$ $(2, 8)$

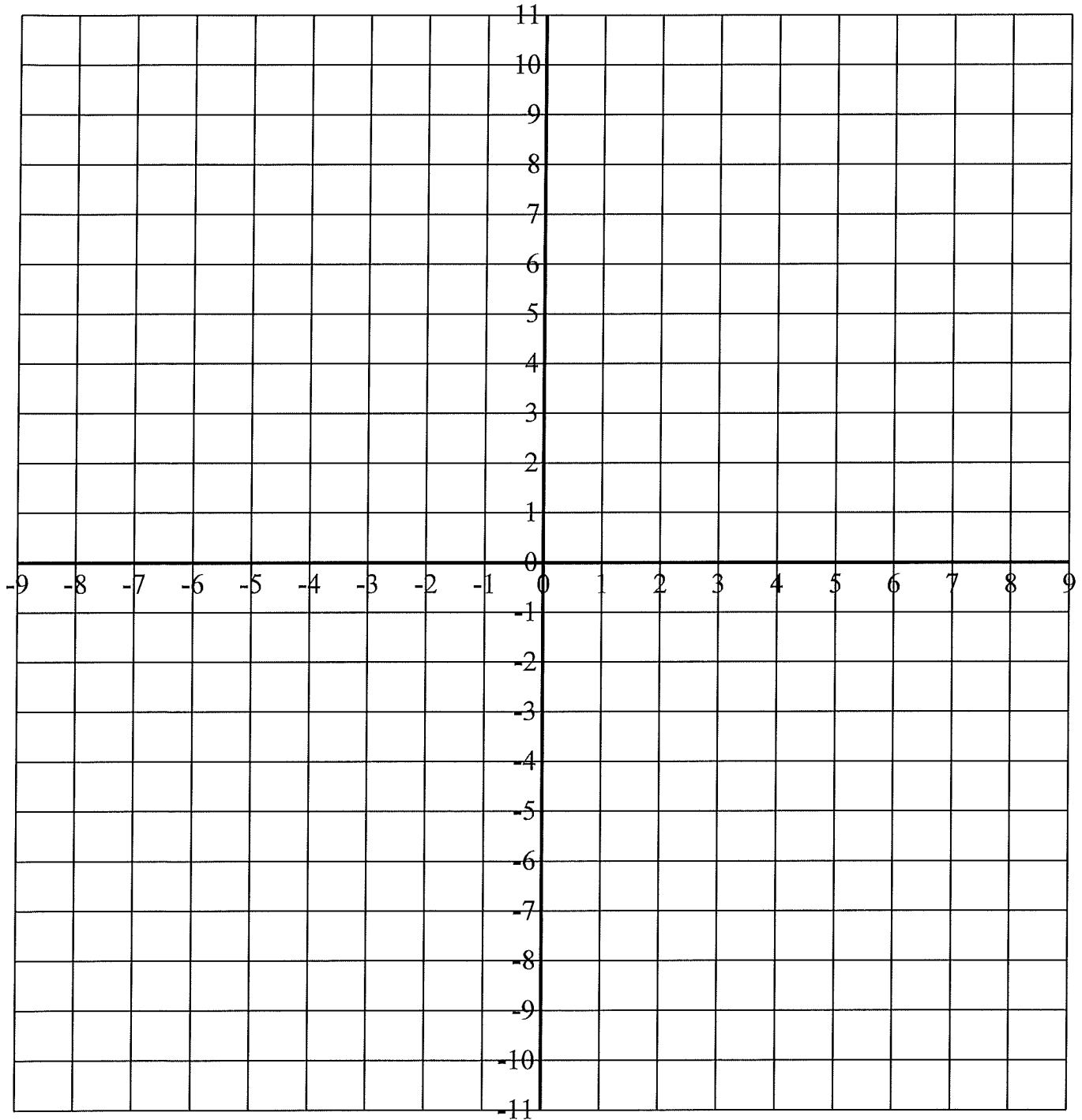

Translations (A)

Draw each translated image.

Translate by $(-2, -3)$.

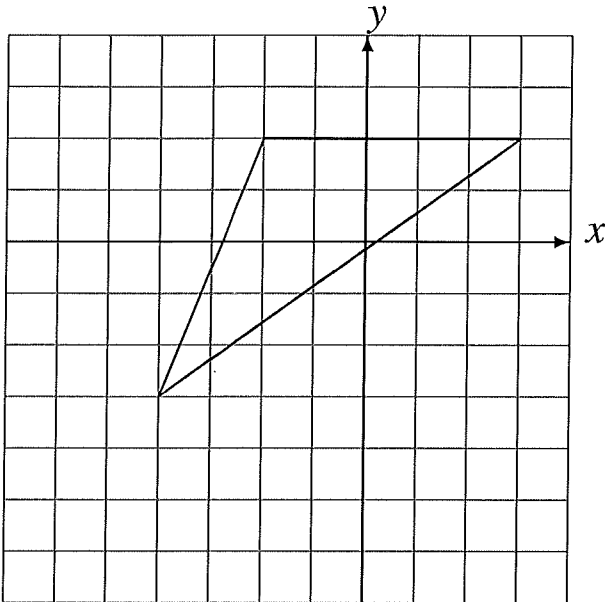

Translate by $(-1, 3)$.

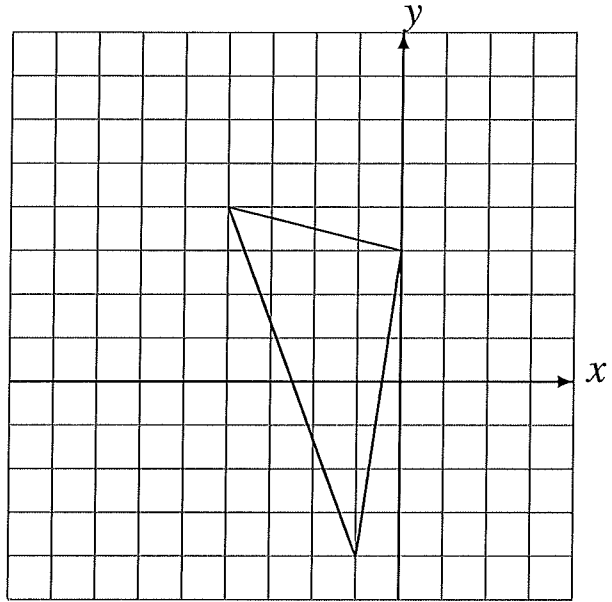

Translate by $(2, 2)$.

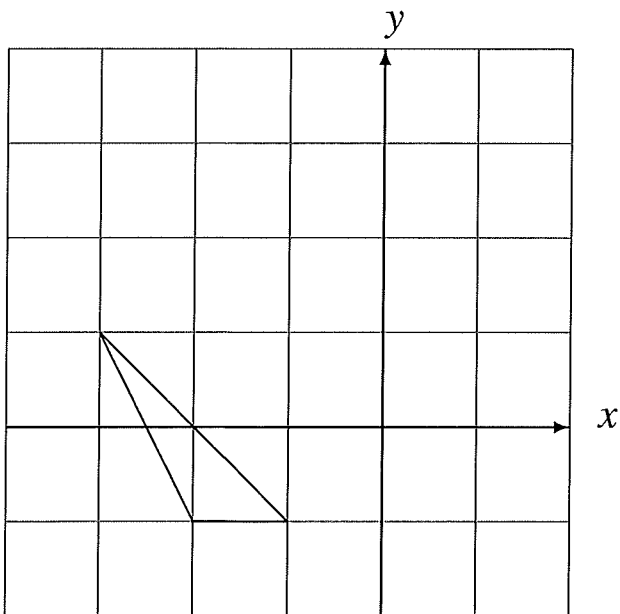

Translate by $(-3, 2)$.

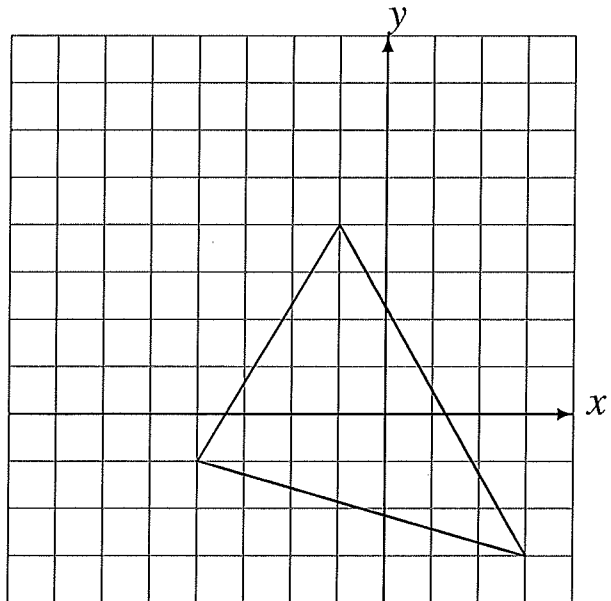

Rotations (A)

Draw the rotated image.

Rotate 90° clockwise about $(0, 0)$.

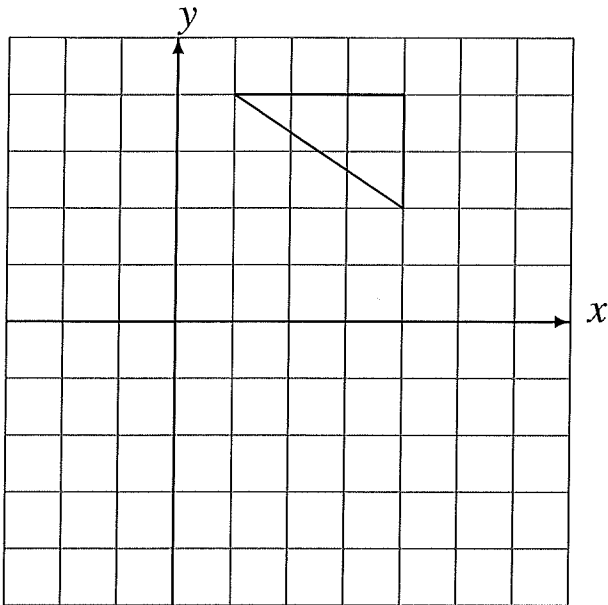

Rotate 90° clockwise about $(0, 0)$.

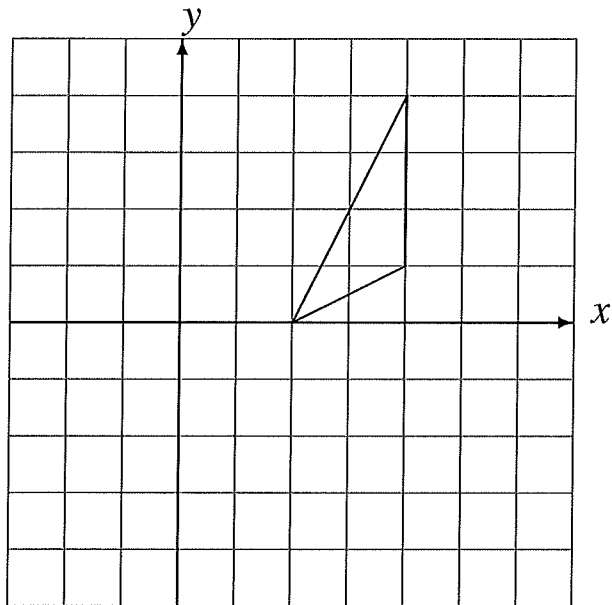

Rotate 90° clockwise about $(0, 0)$.

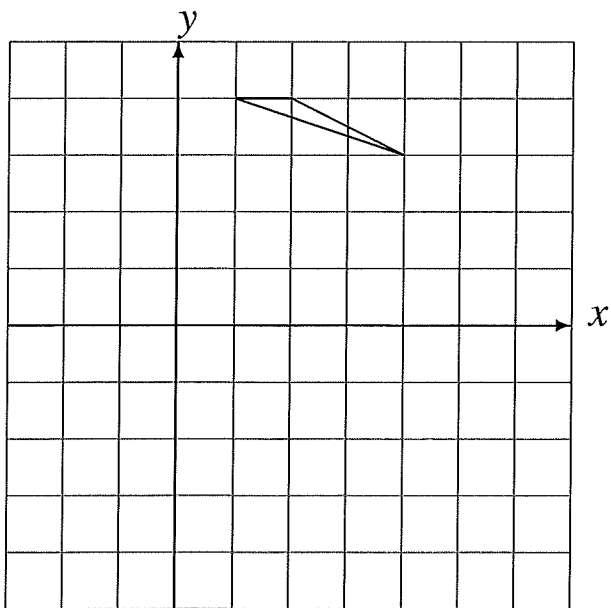

Rotate 90° counterclockwise about $(0, 0)$.

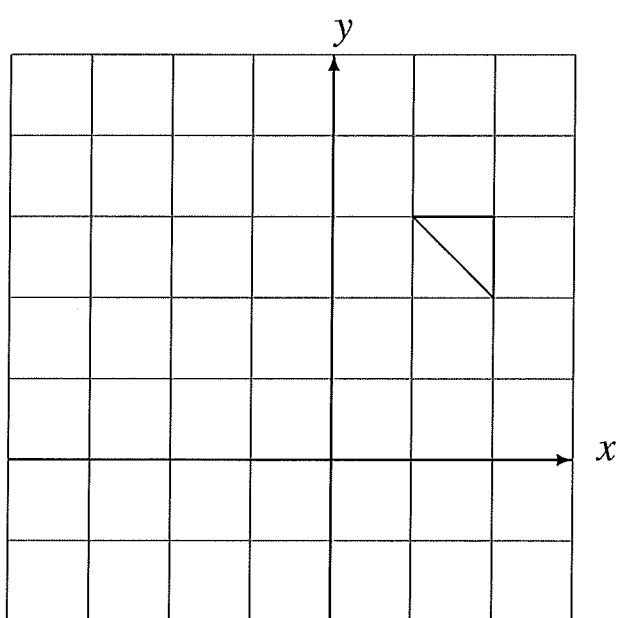

Reflections (A)

Draw each reflected image.

Reflect over $y = 0$.

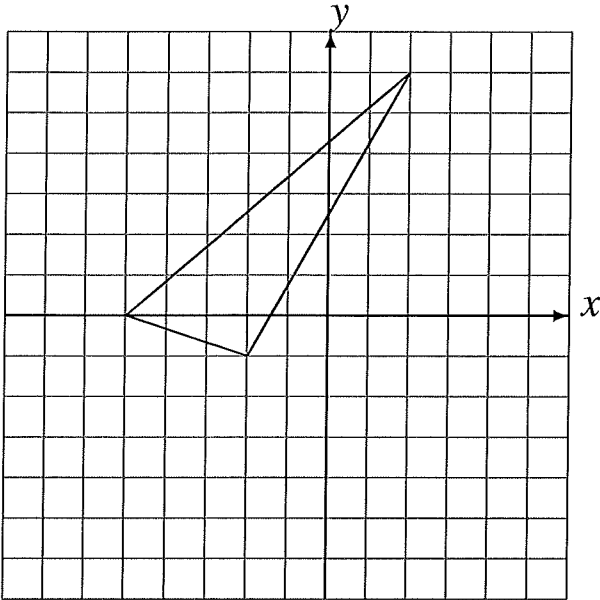

Reflect over $x = 0$.

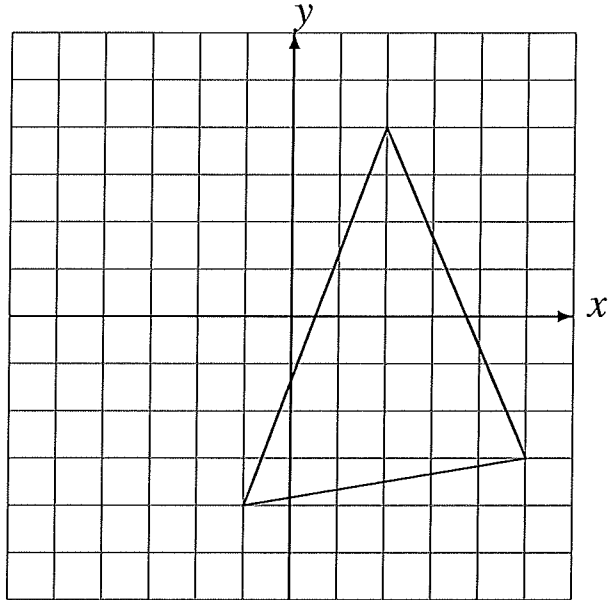

Reflect over $x = 0$.

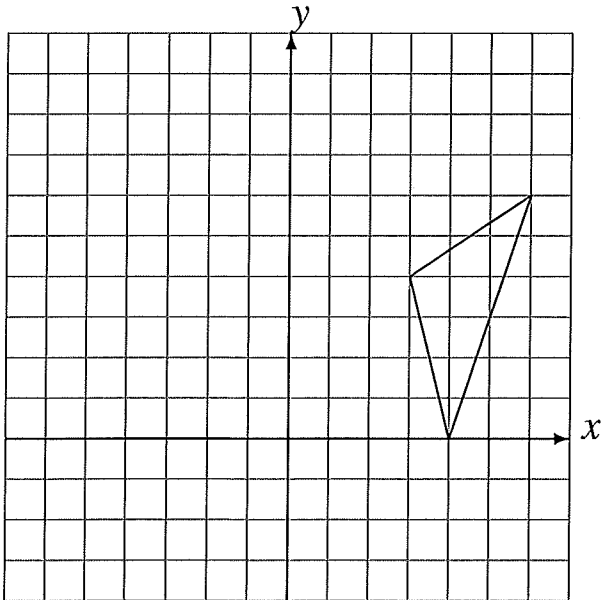

Reflect over $y = 0$.

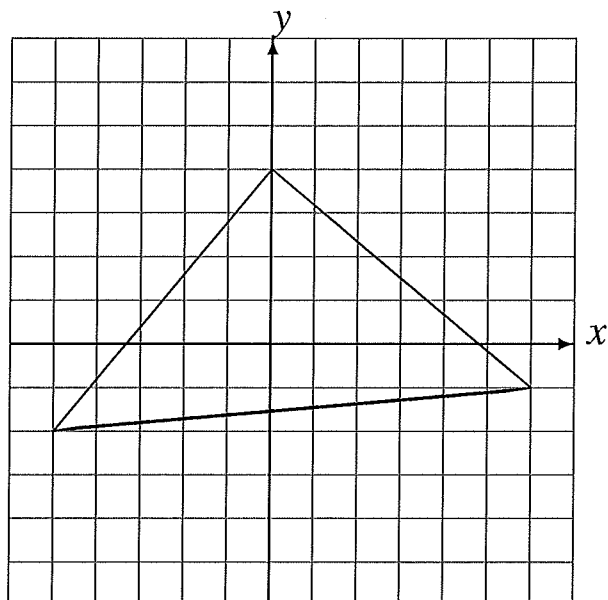

Pythagorean Theorem (A)

Name: _____

Date: _____

Calculate the missing side measurement using $a^2 + b^2 = c^2$.

1.

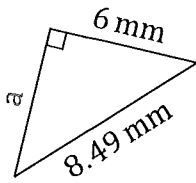

2.

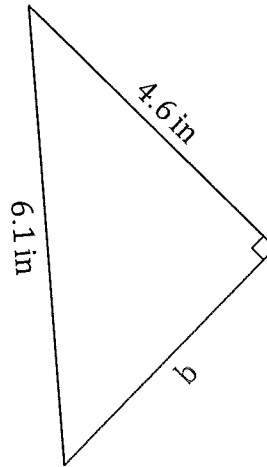

3.

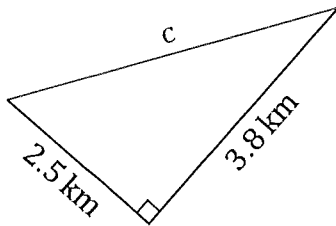

4.

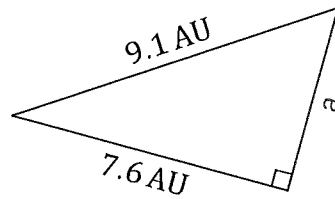

5.

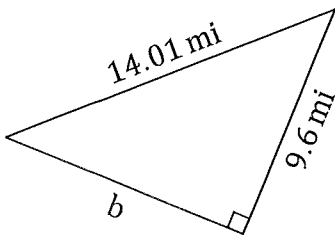

6.

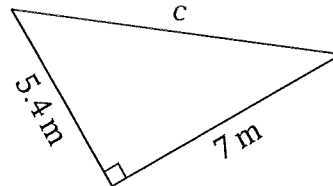

Name : _____ Score : _____

Teacher : _____ Date : _____

Using Similar Polygons

Each polygon pair is similar. Find the missing side length.

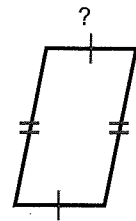
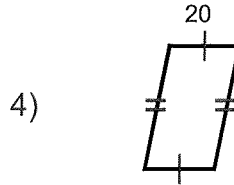
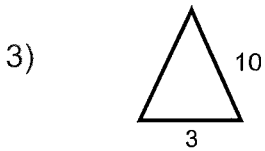
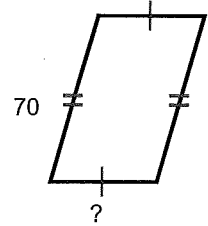
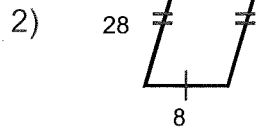

Scale Factor of Left to Right: 4 : 5 _____

Given each polygon pair is similar, find x.

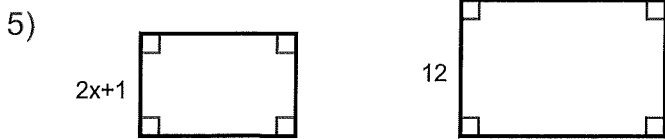

Scale Factor of Left to Right: 1 : 4 _____

Scale Factor of Left to Right: 3 : 5 _____

